

NetGuardian G5 Expansion

(Discretes, Relays, and Analogs)

USER MANUAL



Visit our website at www.dpstele.com for the latest PDF manual and FAQs.

Revision History

March 5, 2012	Updated shipping list
December 2, 2010	Added FCC compliance notice for Class A device
May 10, 2010	Added pinout for build without control relays.
April 16, 2010	D-OC-UM104.16100 released.

This document contains proprietary information which is protected by copyright. All rights are reserved. No part of this document may be photocopied without prior written consent of DPS Telecom.

All software and manuals are copyrighted by DPS Telecom. Said software and manuals may not be reproduced, copied, transmitted or used to make a derivative work, by either mechanical, electronic or any other means in whole or in part, without prior written consent from DPS Telecom, except as required by United States copyright laws.

© 2012 DPS Telecom

Notice

The material in this manual is for information purposes and is subject to change without notice. DPS Telecom shall not be liable for errors contained herein or consequential damages in connection with the furnishing, performance, or use of this manual.

Contents

Visit our website at www.dpstelecom.com for the latest PDF manual and FAQs

1	NetGuardian Expansion Overview	1
1.1	Summary of Features	1
1.2	Introduction	1
2	Installation	2
2.1	Shipping List	2
2.2	Optional Accessories	3
2.3	Specifications	4
2.4	Hardware Installation	5
2.4.1	Site Preparation	5
2.4.2	Installation Steps Overview	5
2.4.3	Mounting Instructions	5
2.4.4	Power and Ground Connection	6
2.4.5	Communication Lines	8
2.4.5.1	NetGuardian Expansion Addressing	9
2.4.6	Alarm and Control Relay Connections	10
2.4.6.1	Alarm, Control, and Analog Connectors (832 DX G5)	11
2.4.6.2	Alarm, Control, and Analog Connectors (864 DX G5)	13
2.4.6.3	Changing Jumper Options	16
2.4.6.4	Analog Dipswitches	18
2.4.7	Power-up	18
2.4.8	NGEdit Configuration	19
2.5	Web Browser Configuration	21
2.5.1	Logon	21
2.5.2	Configuring the Expansion Unit	22
2.5.3	Setting Up An Expansion Alarm	24
2.5.4	Setting Up a Relay	26
2.5.5	Setting Up an Analog	28
3	Operation	29
3.1	Front Panel Functions	29
3.2	Upgrading Firmware	30
3.3	Display Mapping	31
4	Technical Support	33
5	End User License Agreement	34

1 NetGuardian Expansion Overview

1.1 Summary of Features

- Low cost method of expansion to existing NetGuardian 832A or 864A G5 units (supported by NetGuardian G2, G4, G5 and others)
- Gives additional capacity over existing communications lines
- Helps conserve T/MonXM or IAM ports by reporting more alarms to the same address
- 32 or 64 ground activated discrete alarms per expansion
- 8 additional relay contact closures per expansion
- 8 additional analog channels per expansion *
- RS232 ports for easy daisy chaining between units
- LED indications of alarms and communications status
- Easy setup

DPS has kept the operation and interfaces of the DX G5 model very similar to previous DX models. You will find the new DX G5 very interchangeable with existing DX equipment. **Note:** The pinout may vary depending on your DX G5 model, so you may need to adjust connectors to interchange with existing DX equipment.

* When used in conjunction with the NetGuardian 832A or 864A G5 as the base unit. Not compatible as an expansion to the NetGuardian 832A G2 or G4.

1.2 Introduction

The NetGuardian Expansion box is a low cost, self contained device that provides the NetGuardian 832A with an additional 32 or 64 ground activated discrete alarms per unit. With the capacity of adding up to 3 NetGuardian Expansions, at 32 or 64 alarms points per unit, an additional 96 or 192 discrete alarms to the base NetGuardian 832A or 864A can be provided.

To make expansion a simpler and less expensive task, each unit is equipped with dual RS232 ports so that additional Expansions can be daisy chained to one another. In this way, currently deployed NetGuardian 832As can be easily expanded.



Fig. 1.2. NetGuardian Expansion functional diagram

2 Installation

2.1 Shipping List



NetGuardian Expansion D-PK-DX832 OR D-PK-DX864



User Manual
D-OC-UM10C.02100



RJ45 to RJ45 connection cable
D-PR-1028-10C-01



RJ12 to RJ45 connection cable
D-PR-1033-10A-01



3/8" Ear Screws
2-000-60375-05



x2
23" Rack Ears
D-CS-325-10A-01



x2
19" Rack Ears
D-CS-325-10A-00



x4
4 Rack Screws
1-000-12500-06



x2
3/4 AMP fuse
2-741-00750-00



Pads
2-015-00030-00



Zip ties



x2
Two Large Power Connector Plugs for Main Power
2-820-00862-02

2.2 Optional Accessories



**8' RJ45 to RJ45 connection cable
D-PR-1028-10C-08 (1 per unit)
(for connection to NetGuardian 832A G5)**

Note: Please refer to Page 8 for pinout information

2.3 Specifications

Physical Dimensions:	1.720" H x 17.026" W x 9.636" D (NetGuardian 864 DX) 1.720" H x 17.026" W x 8.136" D (NetGuardian 832 DX)
Weight:	2.3 lb
Mounting:	19" or 23" rack with supplied ears
Discrete Alarms:	32 per NetGuardian 832 DX G5 64 per NetGuardian 864 DX G5
Control Relays:	8 (optional)
Analogs:	8 (optional) *
Operating temperature:	41° – 95°F (5° – 35°C)
Power Input	
Voltage Options Include:	–48 VDC (-40 to -70 VDC) (Optional) -24 VDC (-18 to -36 VDC) (Optional) Wide Range -24/-48 VDC (-18 to -58 VDC)
Fuse:	3/4 amp GMT
Current Draw:	250mA
Interfaces:	1 - RJ45 connector for RS232 1 - RJ12 connector for RS232 2 - 50 Pin connectors for discrete alarms, controls, and analogs 1-6 1 - 4-pin connector for analogs 7-8
Protocol:	DCPX
MTBF:	60 years
Windows Compatibility:	Windows 95, 98, NT, ME, XP, 2000, Vista, 7 32/64 bit

* When used in conjunction with the NetGuardian 832A or 864A G5 as the base unit. Not compatible as an expansion to the NetGuardian 832A G2 or G4.

FCC Compliance:

This equipment has been tested and found to comply with the limits for a Class A digital device, pursuant to part 15 of the FCC Rules. These limits are designed to provide reasonable protection against harmful interference when the equipment is operated in a commercial environment. This equipment generates, uses, and can radiate radio frequency energy and, if not installed and used in accordance with the instruction manual, may cause harmful interference to radio communications. Operation of this equipment in a residential area is likely to cause harmful interference in which case the user will be required to correct the interference at his own expense.

2.4 Hardware Installation

2.4.1 Site Preparation

Tools needed:

- Phillips screwdriver
- Small standard No. 2 screwdriver
- Wire strippers/cutters



Precaution

- * *Pull fuses on source of -48VDC before connecting power.*
- * *Always observe electrostatic discharge (ESD) precautions.*

2.4.2 Installation Steps Overview

- Mount hardware:
Mount NetGuardian Expansion in the rack.
- Connect alarms leads.
- Connect power.
- Provision NetGuardian 832A / 864A G5 for NetGuardian Expansion
- Review NetGuardian Expansion status LEDs.

2.4.3 Mounting Instructions

The NetGuardian Expansion can be mounted in a 19" or a "23" rack by using different rack ears for each size. Attach the appropriate size ears for your rack in the flush-mount locations shown in the figures below.

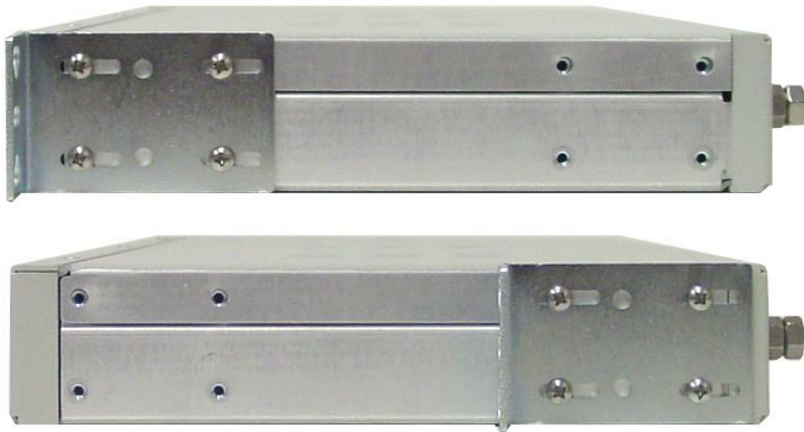

Fig. 2.4.3. The NetGuardian Expansion can be flush (top) or rear-mounted, as shown above.

Note: Rack ears can be flipped 180° for other mounting options not shown.

2.4.4 Power and Ground Connection

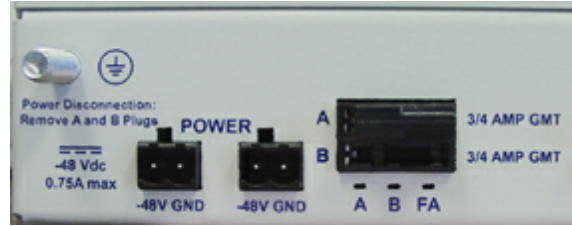

Fig. 2.4.4. Power connectors and fuses

The NetGuardian Expansion has two screw terminal barrier plug power connectors, located on the left side of the back panel. (See Figure 2.4.4.)

Before you connect a power supply to the NetGuardian Expansion, test the voltage of your power supply:

- Connect the black common lead of a voltmeter to the ground terminal of the battery, and connect the red lead of the voltmeter to the battery's -48 VDC terminal. The voltmeter should read **between -43 and -53 VDC**. If the reading is outside this range, test the power supply.

To connect the NetGuardian Expansion to a power supply, follow these steps:

1. Remove Fuse A and Fuse B from the back panel of the NetGuardian Expansion. **Do not reinsert the fuses until all connections to the unit have been made.**
2. Remove the power connector plug from Power Connector A. Note that the plug can be inserted into the power connector only one way - this ensures that the barrier plug can only be reinserted with the correct polarity. Note that the **-48 V terminal is on the left** and the **RTN terminal is on the right**.
3. Use the grounding lug to properly ground the unit.
4. Insert a **battery ground** into the power connector plug's **right terminal** and tighten the screw; then insert a **-48 VDC** line to the plug's **left terminal** and tighten its screw.
5. Push the power connector plug firmly back into the power connector. If the power feed is connected correctly, the LED by the connector will light **GREEN**. The LED by the power connector will be off if the power feed is reversed.
6. Repeat Steps 2–5 for Power Connector B.
7. Reinsert Fuse A and Fuse B to power the NetGuardian Expansion. The front panel LEDs will flash **RED** and **GREEN**.

To connect the NetGuardian to a power supply using a WAGO connector, follow these steps:

1. Remove the **2** fuses (**A & B**) from the back panel of the NetGuardian. **Do not reinsert the fuses until all connections to the unit have been made.**
2. Remove the WAGO power connector. Note that the plug can be inserted into the power connector only one way - this ensures that the barrier plug can only be reinserted with the correct polarity. Note that the **-48 V terminal is on Slots 1 and 3** and the **GND terminal is on Slots 2 and 4**.

3. Use the grounding lug to properly ground the unit.
4. Insert a **battery ground** into the power connector plug's **slots 2 and 4** by pushing down on top of the appropriate slot of the WAGO connector with a screwdriver and inserting the wire into the slot, then releasing the screwdriver. Insert a **-48 VDC** line to the plug's **slots 1 and 3** using the same method as before.

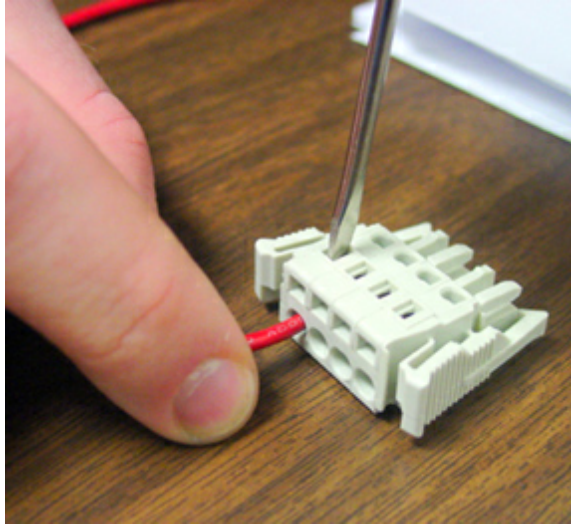

Inserting a -48 VDC Line into Slot 1 of WAGO Connector

5. Push the power connector plug firmly back into the power connector. If the power feed is connected correctly, the LED by the connector will light **GREEN**. If the polarity of the power feed is reversed, the LED will not illuminate.
6. Reinsert the fuses to power the NetGuardian. The front panel LEDs will flash **RED** and **GREEN**.

2.4.5 Communication Lines

1. Connect one end of the RJ45-RJ45 cable to reach through port number 7 (of the 8) located on the NetGuardian G5 back panel.

Note: For NetMediator G5 products (TNT or T2S) use expansion port.

2. Connect the other end of the RJ45-RJ45 cable to the “DX In” port of the NetGuardian Expansion (See Figure 2.3.5 below).

Note: If interfacing to the legacy NetGuardian G2 model, then use the supplied DB9-to-RJ45 cable instead.

If additional NetGuardian Expansions are to be installed:

3. Connect one end of another RJ12-RJ45 cable to the “DX Out” port in the first NetGuardian Expansion.

4. Connect the other end of that RJ12-RJ45 cable to the “DX In” port of the second NetGuardian Expansion.

5. To connect a third NetGuardian Expansion, repeat steps 3 and 4.

Note: The “DX IN” and “DX OUT” ports as well as the NetGuardian’s Data Ports are DCE type ports.

NetGuardian Expansion Units

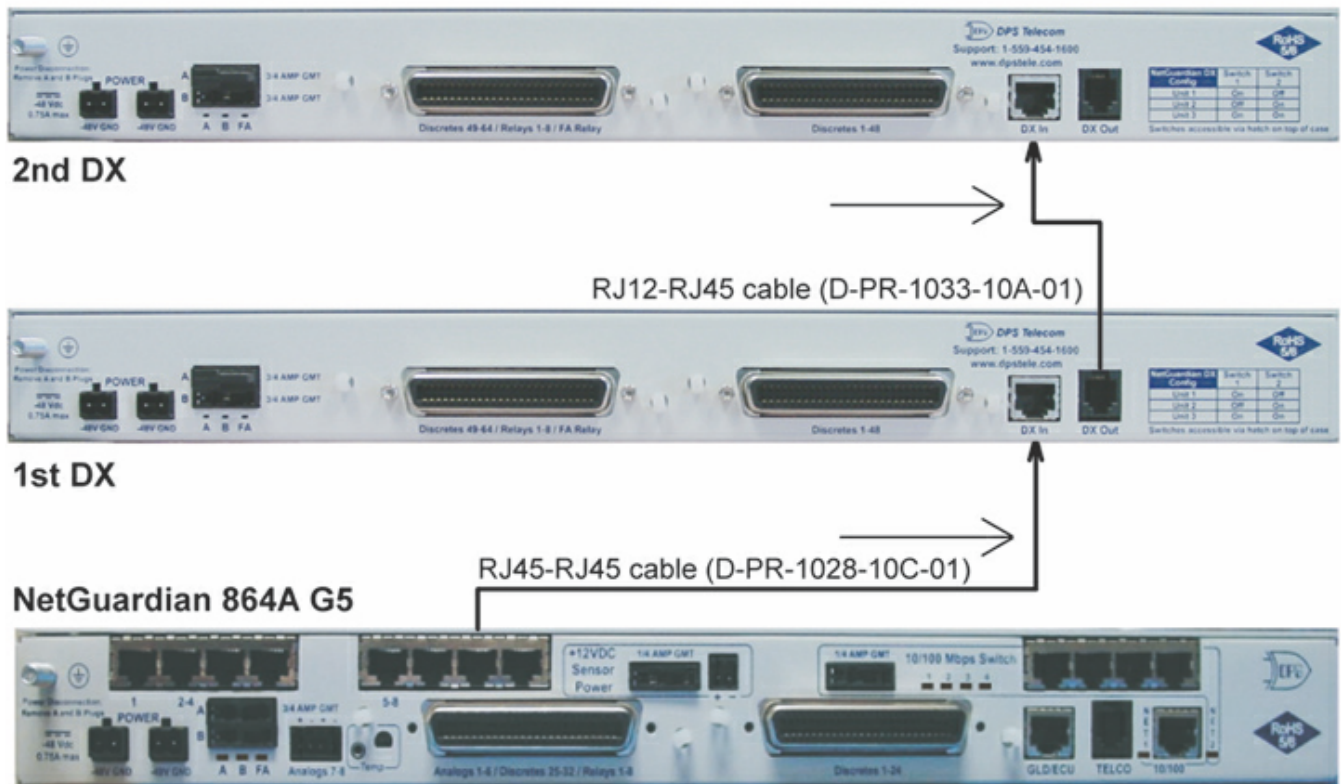
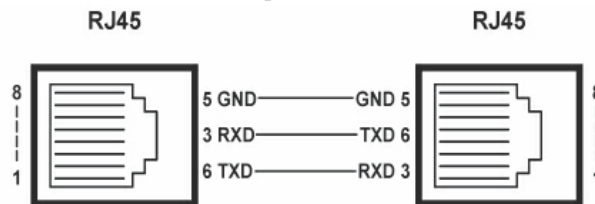

Fig. 2.3.5. NetGuardian Expansion with communications line



Part # D-PR-1028-10C-01

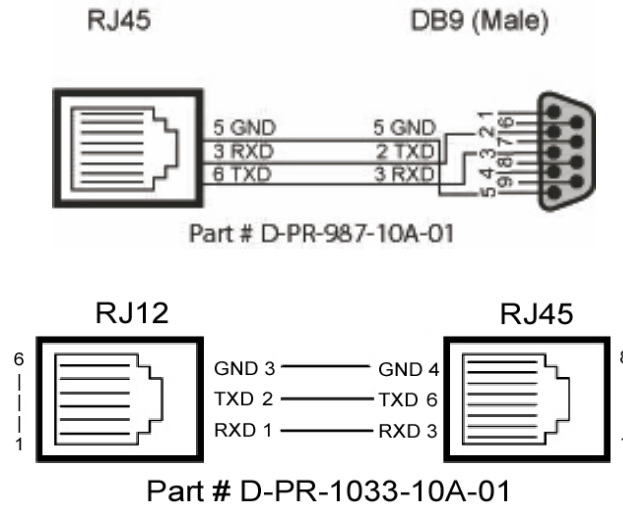

Fig. 2.4.5. Expansion Connection crossover cable pinouts

2.4.5.1 NetGuardian Expansion Addressing

To distinguish NetGuardian Expansion Shelf 1 (and Shelves 2 and 3 if applicable), a DIP switch address setting is used. The DIP switches use binary settings and are addressed as 1, 2, and 3 respectively. To verify the shelf address, push and hold the ACK button on the front panel. An LED will glow red to indicate the shelf address (i.e. either 1, 2, or 3). The switch is accessible via the hatch cover on top of the case (**Fig. 2.4.5.1**). The ACK button will also show the state of relays and acknowledge any new alarms (**see section 3.1**).

NetGuardian Expansion	DIP switch position			
	1	2	3 (Not used)	4 (Not used)
Shelf 1	On	Off	Off	Off
Shelf 2 (if applicable)	Off	On	Off	Off
Shelf 3 (if applicable)	On	On	Off	Off

Table 2.3.5.1. NetGuardian Expansion shelf addressing.



Fig. 2.4.5.1. Shelf addressing DIP switch close-up.

Note: If you only have one NetGuardian Expansion, it must be shelf 1. If a second NetGuardian Expansion unit is used, it must be shelf 2, etc.

2.4.6 Alarm and Control Relay Connections



Fig. 2.4.6 Alarm and control relay connectors

The NetGuardian 832/864 DXs discrete alarm inputs and control relay outputs are connected through the two 50-pin connectors, located on the back panel.

Discrete alarm points connected to the **NetGuardian 864 Expansion** variant are essentially single-lead signals referenced to ground. The B-side of each alarm point is internally wired to ground, so either a single wire bringing a contact to ground or a dry closure with the second lead connected to the B-side will be sensed as an alarm signal.

For the **NetGuardian 832 Expansion** variant, there are 2 leads per alarm signal, and the pinout is exactly the same as a standard NetGuardian 832A.

2.4.6.1 Alarm, Control, and Analog Connectors (832 DX G5)

Discrettes 1–25					
	RTN	ALM		RTN	ALM
ALM 1	1	26	ALM 13	13	38
ALM 2	2	27	ALM 14	14	39
ALM 3	3	28	ALM 15	15	40
ALM 4	4	29	ALM 16	16	41
ALM 5	5	30	ALM 17	17	42
ALM 6	6	31	ALM 18	18	43
ALM 7	7	32	ALM 19	19	44
ALM 8	8	33	ALM 20	20	45
ALM 9	9	34	ALM 21	21	46
ALM 10	10	35	ALM 22	22	47
ALM 11	11	36	ALM 23	23	48
ALM 12	12	37	ALM 24	24	49
			GND	25	50

Discrettes 25–32		
	RTN	ALM
ALM 25	1	26
ALM 26	2	27
ALM 27	3	28
ALM 28	4	29
ALM 29	5	30
ALM 30	6	31
ALM 31	7	32
ALM 32	8	33

Control Relays 1–8		
	NO/NC	CO
CTRL 1	9	34
CTRL 2	10	35
CTRL 3	11	36
CTRL 4	12	37
CTRL 5	13	38
CTRL 6	14	39
CTRL 7	15	40
CTRL 8	16	41
FUSE	17	42

Analog 1–6		
ADC	+	–
ADC 1	19	44
ADC 2	20	45
ADC 3	21	46
ADC 4**	22	47
ADC 5**	23	48
ADC 6**	24	49
GND	25	50

Analog 7–8		
ADC	–	+
7	7–	7+
8	8–	8+

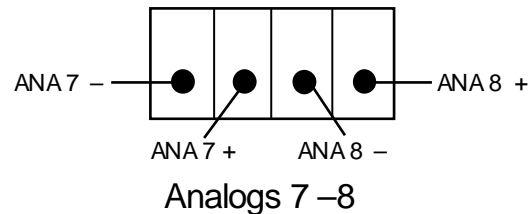

Alarm and control relay connector pinout for the NetGuardian 832A DX G5

Note that the NetGuardian's control relays can be set for either Normally Open or Normally Closed operation. By factory default, all control relays are set to Normally Open. You can reset all relays for Normally Closed operation at the hardware level by resetting a jumper on the NetGuardian circuit board. You can also configure the control relays individually, using either the Web interface or the NGEEditG5 software utility.

For instructions on resetting control relays for Normally Closed operation, see Section 6.12, "Jumper Options."

ADC** channels 4, 5, and 6 may be unavailable for external use. These analog channels are sometimes configured in hardware for monitoring A and B power feeds, and internal temperature. For details regarding your unit's hardware, please reference the product description appendix.

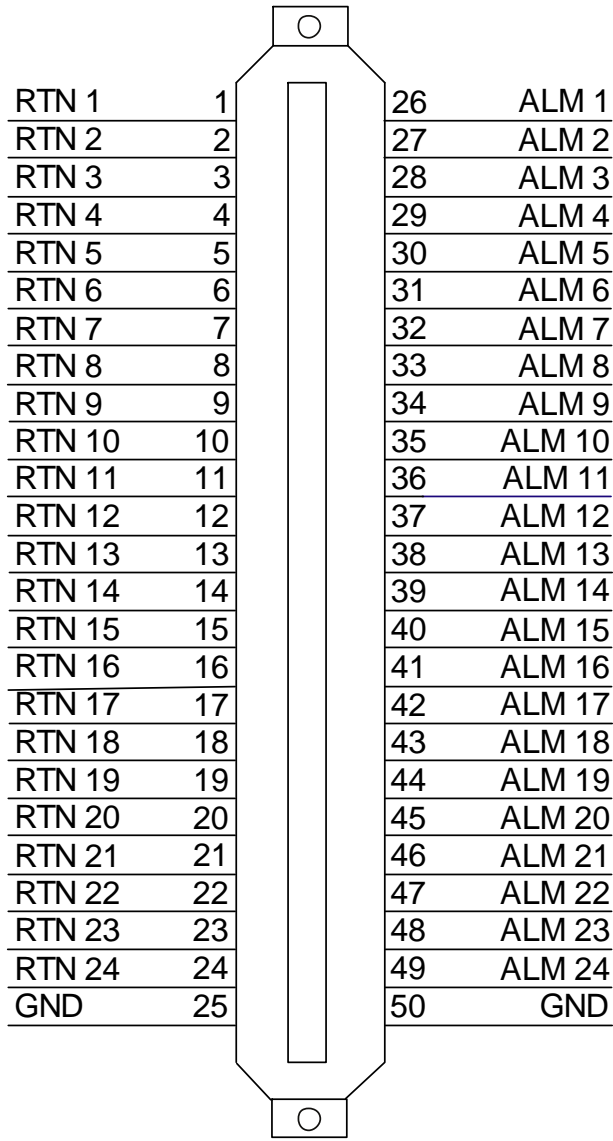

Pinout Diagram for Discretes 1-24 connector on the NetGuardian 832 DX G5.

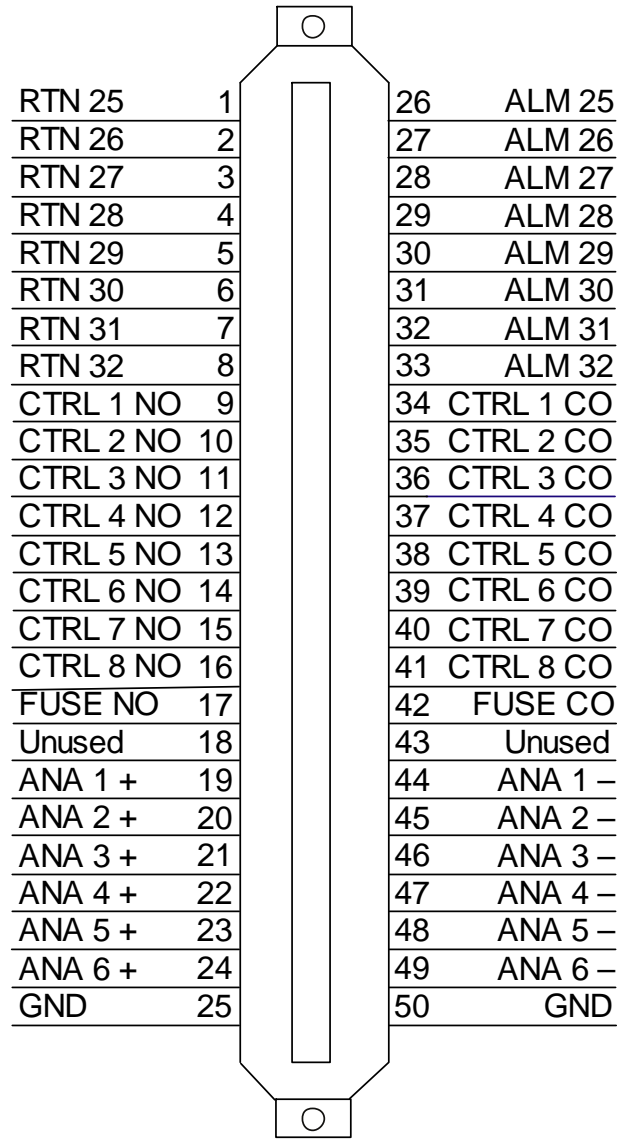

Pinout Diagram for Discretes 24-32, Analogs 1-6, and Relays 1-8 connector on the NetGuardian 832 DX G5.

2.4.6.2 Alarm, Control, and Analog Connectors (864 DX G5)

Discretes 1–48				Discretes 49-64, Relays 1-8, Analogs 1-6				Analogs 7-8		
ALM	PIN		ALM	PIN	ALM	PIN	Relays 1-8			
1	26		26	13	49	26	RLY 1	9	34	
2	1		27	39	50	1	RLY 2	10	35	
3	27		28	14	51	27	RLY 3	11	36	
4	2		29	40	52	2	RLY 4	12	37	
5	28		30	15	53	28	RLY 5	13	38	
6	3		31	41	54	3	RLY 6	14	39	
7	29		32	16	55	29	RLY 7	15	40	
8	4		33	42	56	4	RLY 8	16	41	
9	30		34	17	57	30	FUSE	17	42	
10	5		35	43	58	5	ADC	+	-	
11	31		36	18	59	31	ADC 1	19	44	
12	6		37	44	60	6	ADC 2	20	45	
13	32		38	19	61	32	ADC 3	21	46	
14	7		39	45	62	7	ADC 4**	22	47	
15	33		40	20	63	33	ADC 5**	23	48	
16	8		41	46	64	8	ADC 6**	24	49	
17	34		42	21			GND	25		
18	9		43	47			GND/RTN*	50		
19	35		44	22						
20	10		45	48						
21	36		46	23						
22	11		47	49						
23	37		48	24						
24	12		GND	25						
25	38		GND/RTN*	50						

Alarm and relay connection pinouts for NetGuardian 864 DX G5

RTN* is the alarm return pin. Alarms on standard units are dry closure or ground closure. Most units will have RTN internally tied to GND. However, special hardware assemblies may have RTN isolated from GND. For details regarding your unit's hardware, please reference the product description appendix.

ADC** channels 4, 5, and 6 may be unavailable for external use. These analog channels are sometimes configured in hardware for monitoring A and B power feeds, and internal temperature. For details regarding your unit's hardware, please reference the product description appendix.

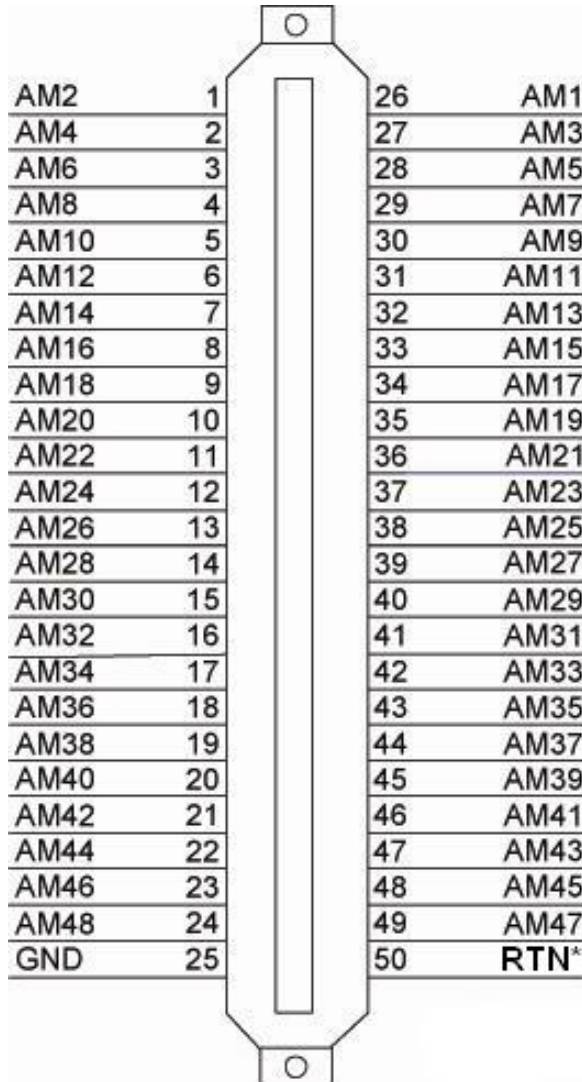

Pinout Diagram for Discretives 1-48 Connector on the NetGuardian 864A DX

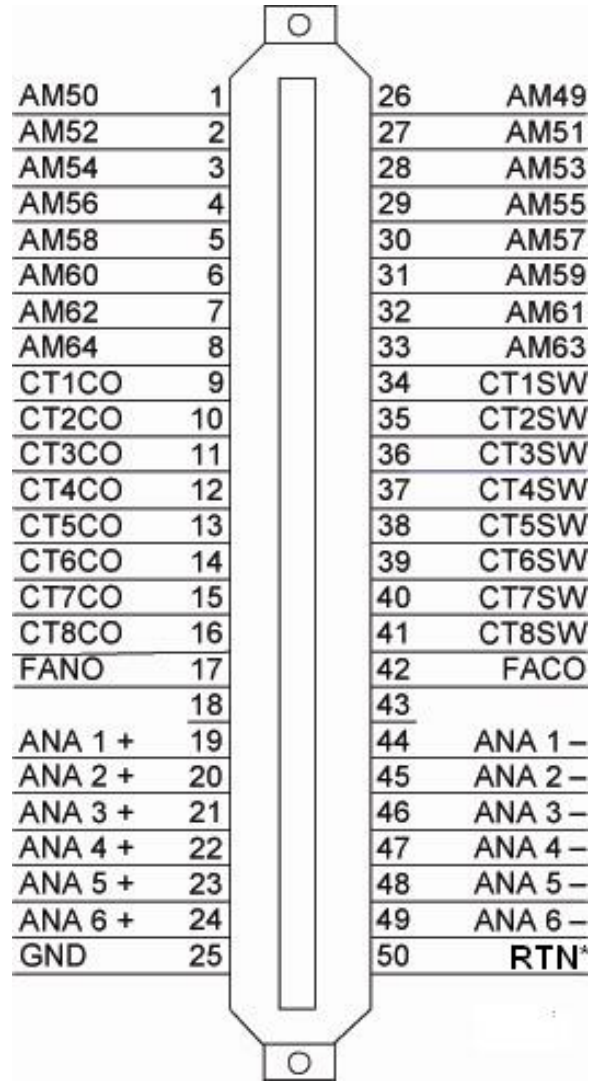

Pinout Diagram for Analogs 1-6/Discretives 49-64/Relays 1-8 Connector

RTN* is the alarm return pin. Standard configurations have this pin tied to GND. While it is possible to change this configuration to utilize different types of alarms (i.e. TTL, Open Collector, Battery Closure), the hardware must be ordered in that configuration. It is **NOT** field-adjustable.

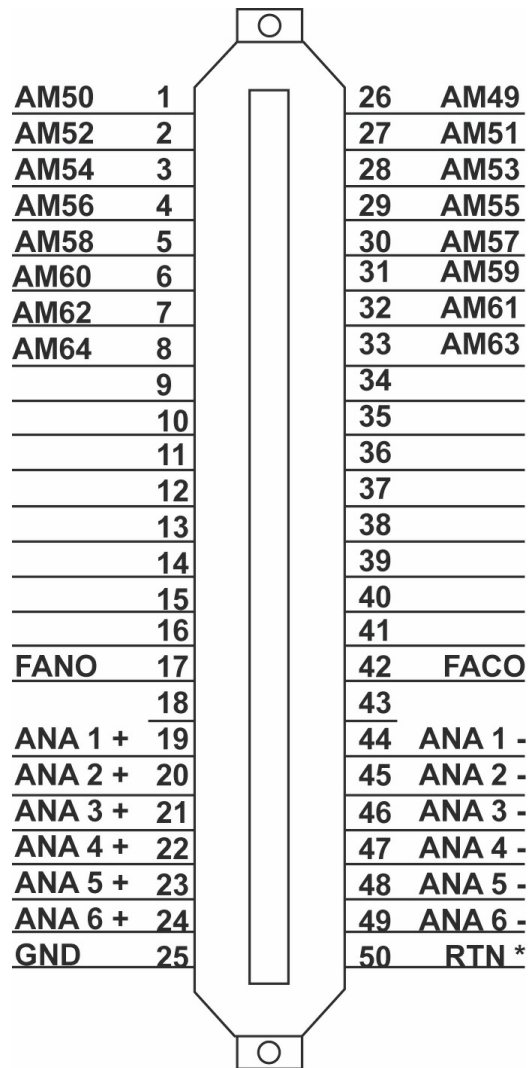

Pinout Diagram for Analogs 1-6/Discretes 49-64. This pinout only applies to the NetGuardian 864 DX G5 without relays. See note below.

Note: Figure 6.6.5.2 is a special pinout for a particular build of the NetGuardian 864 DX G5 without control relays. It only applies to the following part number: **D-PK-DX864-12007.00001**

2.4.6.3 Changing Jumper Options

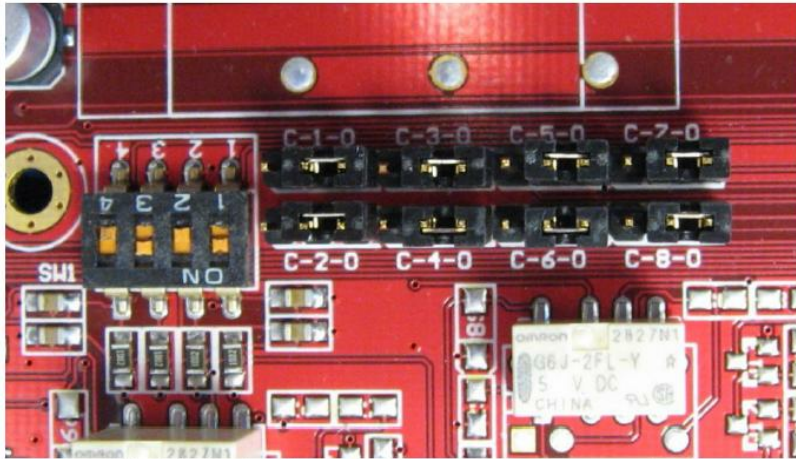
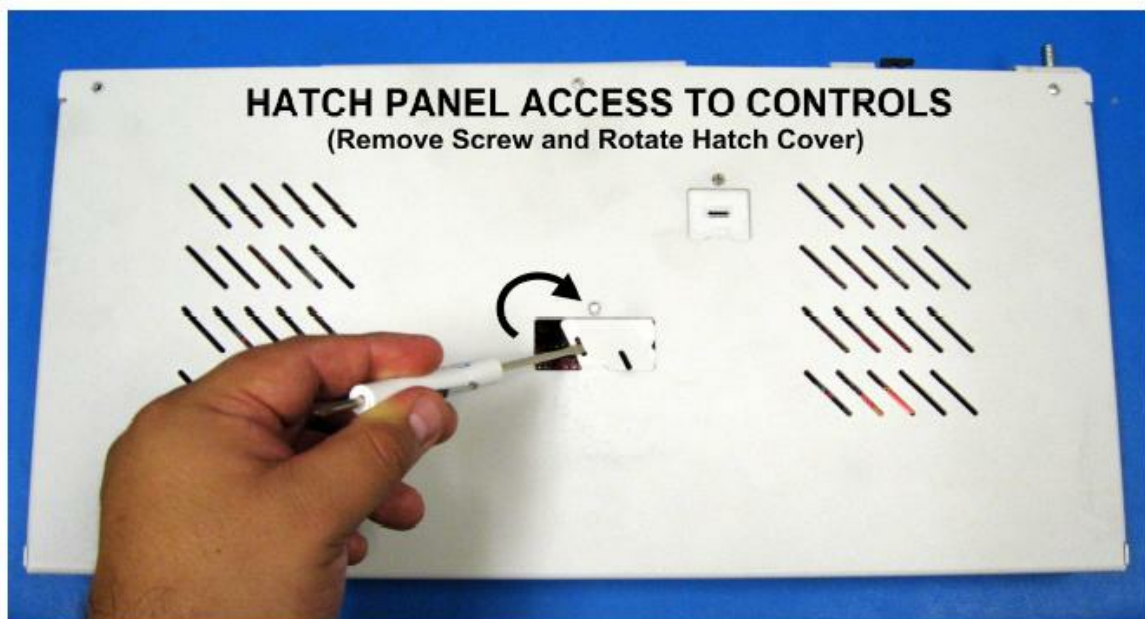

Fig. 2.4.6.2.1 Adjustable jumpers on the NetGuardian circuit board

The following options are adjusted by resetting jumpers on the NetGuardian DX's circuit board:

- Control relays can be switched from normally open (N/O) to normally closed (N/C)

To simply configure the jumpers, use the hatch panel access on the top of the NetGuardian DX chassis. This allows for easy access and configuration of jumpers without having to open the entire case. Remove top screw on hatch panel and rotate hatch cover until you can easily reach the jumpers. Figure 2.4.6.2.1 shows the circuit board and the location of the adjustable jumpers.



Hatch Panel Access on Top of NetGuardian DX G5 Chassis

WARNING: Always observe anti-static precautions whenever opening the unit.

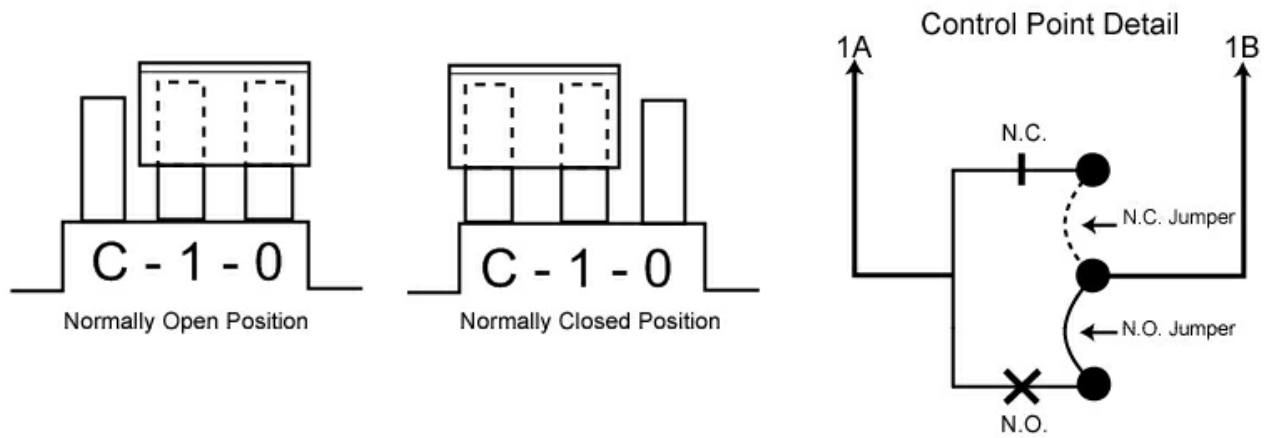
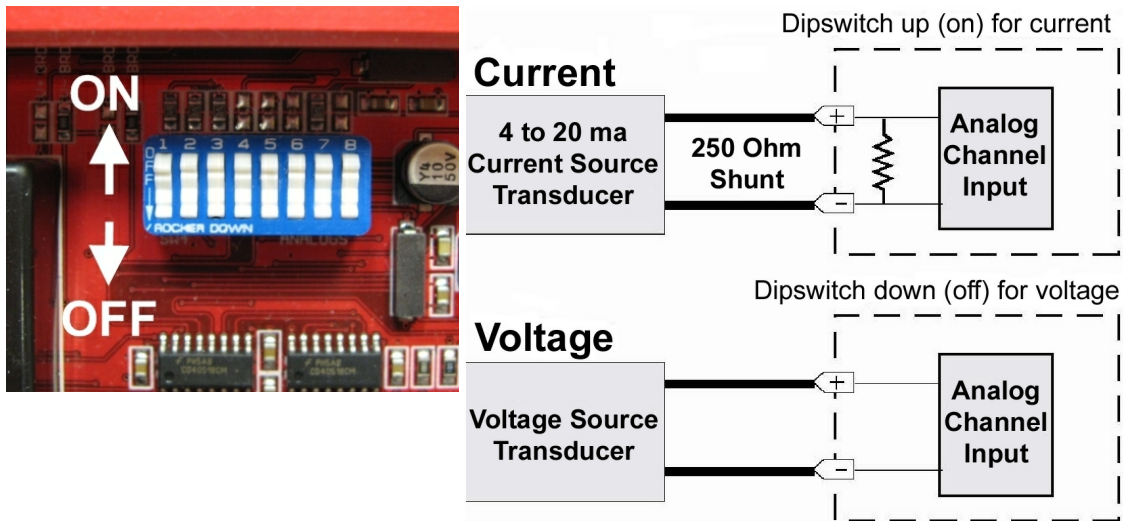

Fig. 2.4.6.2.2. Jumper settings for control relays

For control relay jumpers, the open position corresponds to normally open operation, and the closed position corresponds to normally closed operation. See Figure 2.4.6.2.2.

Note: Default settings may be different if you ordered a special configuration NetGuardian.

2.4.6.4 Analog Dipswitches



The analogs are controlled by the dipswitches accessible via the top sliding panel. For milliamp sensor operation (current loop), turn the dipswitch on by placing it in the up (ON) position. For voltage operation, place the dipswitch in the down (OFF) position.

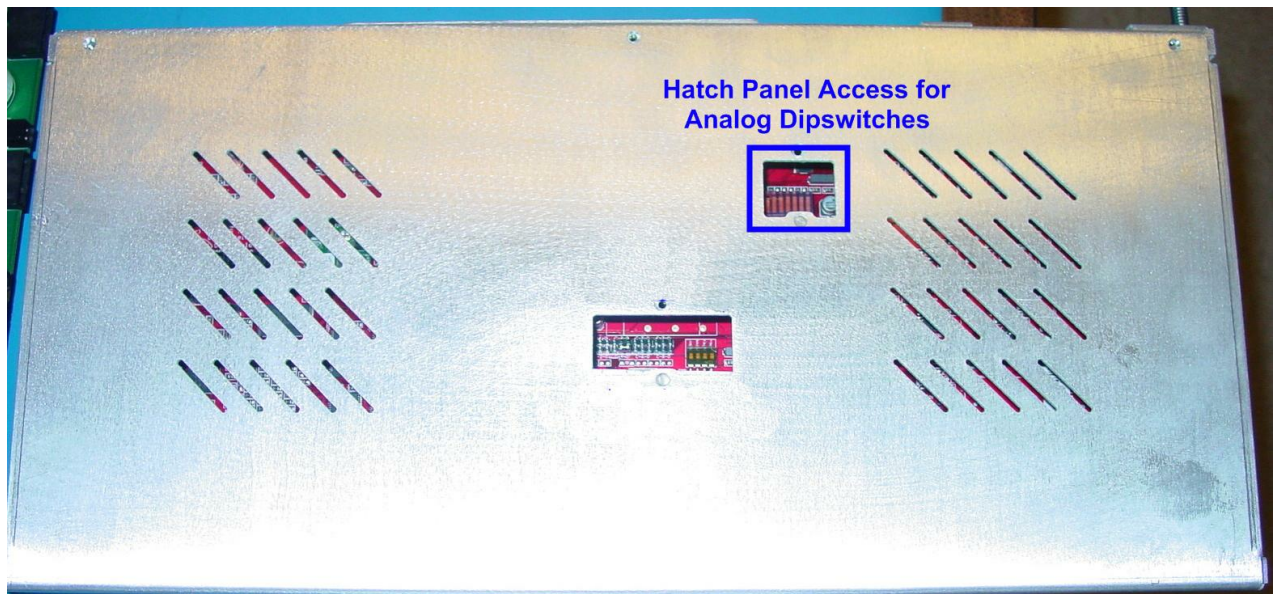

You can access the analog dipswitches via the sliding hatch panel on top of the unit

WARNING: Do not put the dipswitches in the upward, ON position (current loop mode) unless you are sure of the analog setting. Having the dipswitch on puts a 250 ohm resistor across the input lines. Any voltage beyond 5V or 20 mA will damage components.

2.4.7 Power-up

Now that all alarm and communications wiring is complete, power up the unit by installing Fuse A and Fuse B in the back panel.

2.4.8 NGEEdit Configuration

NGEditG5 is the DPS-recommended way for configuring points on the NetGuardian DX. You can refer to the NGEEditG5 Help File or the NGEEditG5 User Manual for full instructions. The following is to show you the screens you would use to configure the NetGuardian DX.

The screenshot shows the NGEEditG5 configuration interface. The 'Ports' tab is active, displaying configuration for two Ethernet ports (NET 1 and NET 2), Global Ethernet Options, and Modem settings. A dropdown menu is open for 'Options', showing '3-DX units' selected. Below the options is a table of 'Data Ports' and an 'Expansion' section.

Data Ports Table:

ID	Description	Baud	WFmt	CRX In	CRX Out	RTS Head	RTS Tail	Port Type	Pool
1		115200	8N1	Ignore	Ignore	0	0	Off	No
2		115200	8N1	Ignore	Ignore	0	0	Off	No
3		115200	8N1	Ignore	Ignore	0	0	Off	No
4		115200	8N1	Ignore	Ignore	0	0	Off	No
5		115200	8N1	Ignore	Ignore	0	0	Off	No
6		115200	8N1	Ignore	Ignore	0	0	Off	No
7	NGDdx Net	2400	8N1	Ignore	Ignore	0	0	Off	No
8		115200	8N1	Ignore	Ignore	0	0	Off	No

Expansion Table:

ID	Description	Baud	WFmt	CRX In	CRX Out	RTS Head	RTS Tail	Port Type	Pool
9		115200	8N1	Ignore	Ignore	0	0	Off	No

Click the Ports tab to access the Options drop-down menu

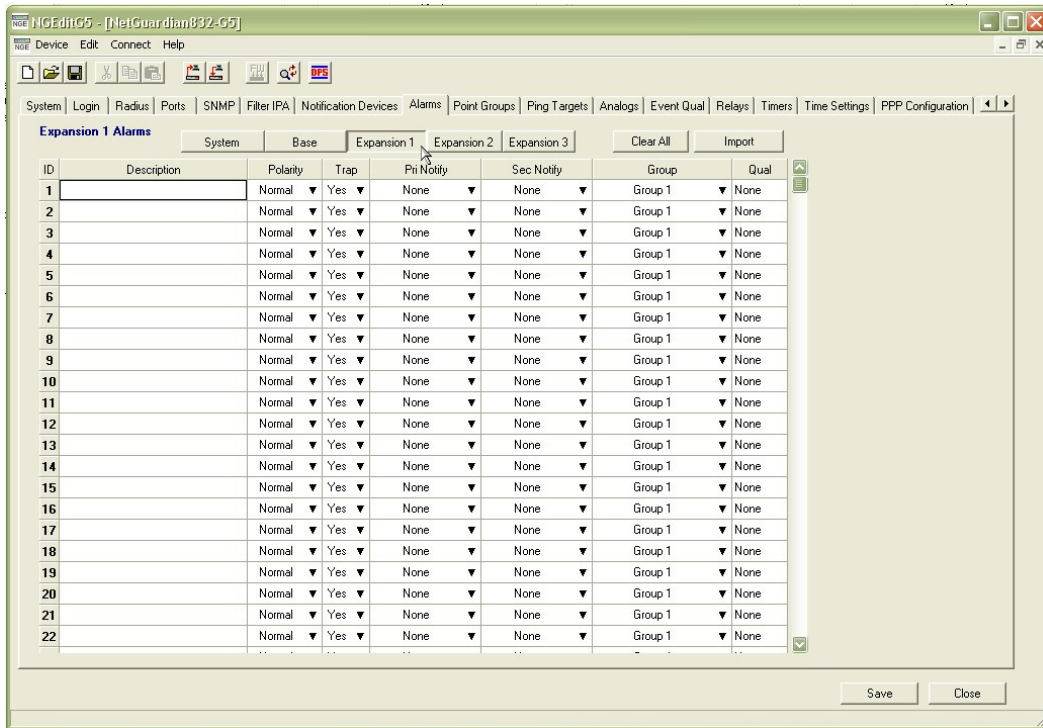

Configure Your Selected DX with the Alarms Tab.

- When you click on the Expansion tab in the Alarms screen, enter the appropriate event in the Description field.

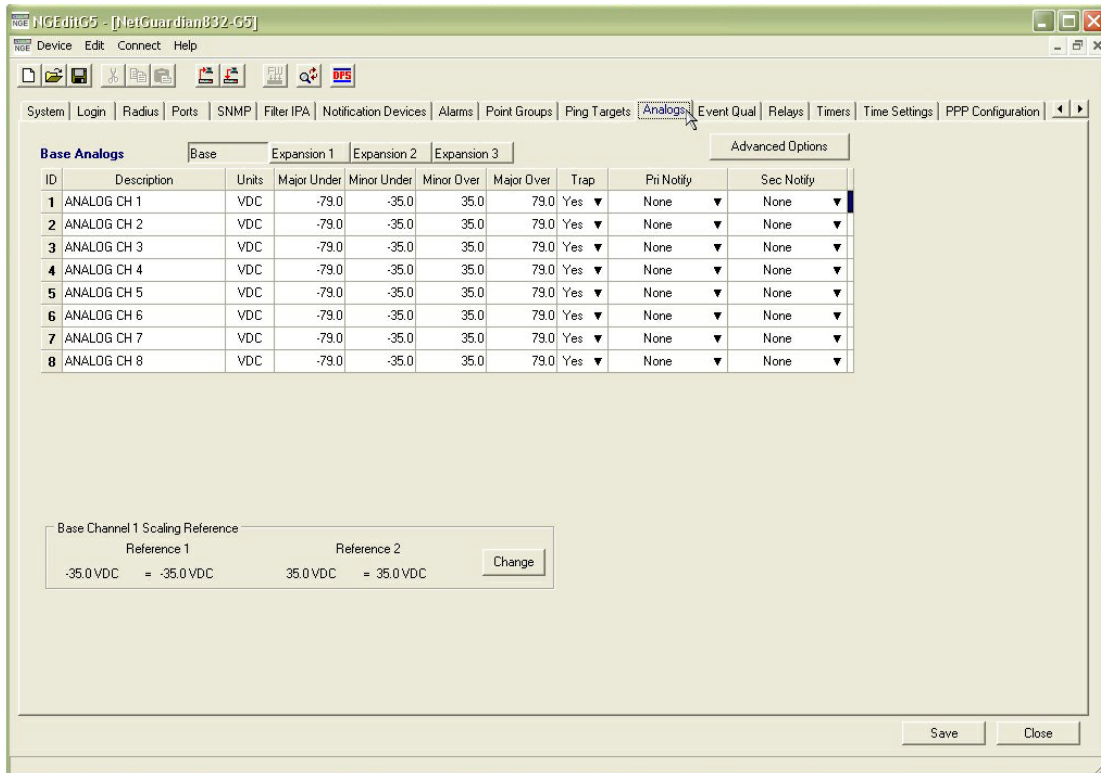

Configure the expansion unit's analogs in the Analogs tab.

- Click on the Analogs tab to enter in the analog descriptions, threshold settings, and notification choices for the expansion units.

2.5 Web Browser Configuration

The **base NetGuardian 832A or 864A G5** offers Web Browser configuration for easy and convenient setup of the discrete alarms. The NetGuardian 864 DX supports Internet Explorer versions 6.0 and up and Netscape Navigator versions 4.7 and up.

2.5.1 Logon

1. After connecting to the NetGuardian's IP address, enter your password and click Submit (factory default password is "dpstelecom"). (See figure 2.5.1)
2. In the main menu, there is a Monitor menu button and an Edit menu button. Most of the software configuration will occur in the Edit menu.



NetGuardianG5 Logon

Password: submit



Fig. 2.5.1. Enter your password to configure and monitor your NetGuardian's discrete alarms using the Web Browser feature

2.5.2 Configuring the Expansion Unit

When you first logon, you will see the Alarm Summary window in Monitor Mode.

The screenshot shows the NetGuardianG5 web interface. At the top left is the 'DPS Telecom' logo. At the top center is the title 'NetGuardianG5'. At the top right are links for 'Refresh', 'Logout', 'Upgrade', and 'Help'. On the left side, there is a 'Monitor' sidebar with a list of menu items: Summary, Base Alarms, Ping Targets, Analogs, System Alarms, Accum. Timer, Controls, Exp. 1 Controls, Exp. 1 Alarms, Event Log, Port Transmit (with a 'Select' dropdown), and Port Receive (with a 'Select' dropdown). Below the sidebar, the version 'NetGuardian-G5 v5.0B.3206' is displayed, and a green 'Edit' button is located at the bottom left of the main content area.

The main content area displays the 'Alarm Summary' window. It features a table with two columns: 'Type' and 'Active Alarms'. The data is as follows:

Type	Active Alarms
Base Alarms	1
Ping Targets	0
Analogs	0
System Alarms	1
Exp.1 Alarms	1

Below this table is a section titled 'Summary by Group' with another table:

Name	Active Alarms
Group 1	3
Group 2	0
Group 3	0
Group 4	0
Group 5	0
Group 6	0
Group 7	0
Group 8	0

Alarm Summary Window in Monitor Mode

To configure your Expansion Unit, click on the Edit link on the bottom left-hand corner of the Alarm Summary window.

1. Once you are in the Edit screen, click on 'Edit Ports'
2. Once in the Edit Ports screen, use the NGDdx drop-down menu in the Options section to select how many DX units you will be working with. For this example, we will choose 1 DX unit.

The screenshot shows the 'Options' section of the configuration interface. It contains two rows: 'NGDdx' and 'GLD or BSU'. The 'NGDdx' dropdown menu is open, displaying the following options: '0-NONE', '1-DX unit' (which is highlighted with a mouse cursor), '2-DX units', '3-DX units', and '1-480DX unit'. To the right of the dropdown menu is a 'Submit Data' button.

Select Expansion Units from the NGDdx drop-down menu in the Options section

3. Click Submit Data
4. At this point, refresh the browser. You will see 2 new entries in the EDIT menu: Exp 1 Controls and Exp 1 Alarms.



NetGuardianG5

Refresh | Logout | Upgrade

Monitor

NetGuardian G5 v5.00.0006

Edit

- System
- Logon
- RFormat
- Ports
- Filter IP
- SNMP
- Notification
- Point Groups
- Base Alarm
- Analogs
- System Alarm
- Account Time
- Ping Targets
- Controls
- Exp. 1 Controls
- Exp. 1 Alarm
- Event Que
- Select ▼
- Timers
- Date and Time
- PPP
- Exp.

Ports

Craft

Baud	9600 ▼
WFmt	8,N,1 ▼

Modem

Ring Count	1
Answer Init	
Dial Init	

Data Ports

ID	Description	Baud	WFmt	CR/LF Mode		RTS Times		Type	Pool
				In	Out	Head	Tail		
1		115200	8,N,1	Ignore	Ignore	0	0	OFF	N
2		115200	8,N,1	Ignore	Ignore	0	0	OFF	N
3		115200	8,N,1	Ignore	Ignore	0	0	OFF	N
4		115200	8,N,1	Ignore	Ignore	0	0	OFF	N
5		115200	8,N,1	Ignore	Ignore	0	0	OFF	N
6		115200	8,N,1	Ignore	Ignore	0	0	OFF	N
7	NGDdx Net	2400	8,N,1	Ignore	Ignore	0	0	OFF	N
8	ECU Net	9600	8,N,1	Ignore	Ignore	0	0	ECU	N
9		115200	8,N,1	Ignore	Ignore	0	0	OFF	N

There are 2 new entries in the Edit Menu after you select a DX in the Options Menu

2.5.3 Setting Up An Expansion Alarm

To configure an alarm for your expansion unit simply do the following:

1. Click on the **Exp 1 Alarms** link in the Edit Menu

The screenshot shows the NetGuardianG5 web interface. At the top left is the DPS Telecom logo. At the top center is the title 'NetGuardianG5'. At the top right are links for 'Refresh', 'Logout', 'Upgrade', and 'Help'. On the left side, there is a navigation menu with a 'Monitor' button at the top and an 'Edit' button below it. Under 'Edit', there is a list of menu items including System, Logon, Ethernet, Ports, Filter IPA, SNMP, Notification, Point Groups, Base Alarms, System Alarms, Accum. Timer, Ping Targets, Analogs, Controls, Exp.1 Controls, Exp.1 Alarms, Event Qual (with a 'Select' dropdown), Timers, Date and Time, PPP, BAC, Camera, Alarm Sync, Reboot, and NVRam. The main content area is titled 'Exp.1 Alarms' and contains a table with the following structure:

ID	Description	Polarity	Trap	Pagers		Group	Qual
				primary	secondary		
1		Normal	<input type="checkbox"/>	0	0	1	None
2		Normal	<input type="checkbox"/>	0	0	1	None
3		Normal	<input type="checkbox"/>	0	0	1	None
4		Normal	<input type="checkbox"/>	0	0	1	None
5		Normal	<input type="checkbox"/>	0	0	1	None
6		Normal	<input type="checkbox"/>	0	0	1	None
7		Normal	<input type="checkbox"/>	0	0	1	None
8		Normal	<input type="checkbox"/>	0	0	1	None
9		Normal	<input type="checkbox"/>	0	0	1	None
10		Normal	<input type="checkbox"/>	0	0	1	None
11		Normal	<input type="checkbox"/>	0	0	1	None
12		Normal	<input type="checkbox"/>	0	0	1	None
13		Normal	<input type="checkbox"/>	0	0	1	None
14		Normal	<input type="checkbox"/>	0	0	1	None
15		Normal	<input type="checkbox"/>	0	0	1	None
16		Normal	<input type="checkbox"/>	0	0	1	None
17		Normal	<input type="checkbox"/>	0	0	1	None
18		Normal	<input type="checkbox"/>	0	0	1	None
19		Normal	<input type="checkbox"/>	0	0	1	None
20		Normal	<input type="checkbox"/>	0	0	1	None
21		Normal	<input type="checkbox"/>	0	0	1	None
22		Normal	<input type="checkbox"/>	0	0	1	None

The Exp.1. Alarms Window

2. Enter the desired alarm description and values
3. Click Submit Data
4. Exit to 'Monitor Mode' by clicking on the Monitor link in the upper-left hand corner of the screen.

5. The Alarm Summary window will show the newly-configured Exp 1. alarm.



NetGuardianG5

[Refresh](#) | [Logout](#) | [Upgrade](#) | [Help](#)

Monitor

- Summary
- Base Alarms
- Ping Targets
- Analog
- System Alarms
- Accum. Timer
- Controls
- Exp.1 Controls
- Exp.1 Alarms
- Event Log
- Port Transmit
Select ▼
- Port Receive
Select ▼

Alarm Summary	
Type	Active Alarms
Base Alarms	1
Ping Targets	0
Analog	0
System Alarms	1
Exp.1 Alarms	1
Summary by Group	
Name	Active Alarms
Group 1	3
Group 2	0
Group 3	0
Group 4	0
Group 5	0
Group 6	0
Group 7	0
Group 8	0

NetGuardian-G5 v5.0B.3206

Edit

The Alarm Summary Window showing a newly-active Exp.1 Alarm

6. Click on the Exp.1 Alarms link to view your alarm information.

2.5.4 Setting Up a Relay

1. Click on the Edit link in the bottom left-hand corner of the Alarm Summary Window.
2. Once in the Edit screen, click 'Exp 1 Controls'
3. Enter the description for the relay and click Submit Data

The screenshot shows the NetGuardianG5 web interface. At the top, there is a logo for DPS Telecom and the title 'NetGuardianG5'. On the right, there are links for 'Refresh', 'Logout', 'Upgrade', and 'Help'. The main content area is divided into two sections. On the left is a navigation menu with a 'Monitor' button at the top and an 'Edit' button below it. The 'Edit' menu includes various system settings like System, Logon, Ethernet, Ports, Filter IPA, SNMP, Notification, Point Groups, Base Alarms, System Alarms, Accum. Timer, Ping Targets, Analogs, Controls, Exp.1 Controls, Exp.1 Alarms, Event Qual (with a dropdown menu), Timers, Date and Time, PPP, BAC, Camera, Alarm Sync, Reboot, and NVRam. The main area displays a table titled 'Exp.1 Controls' with the following data:

ID	Description	Test	Energize State	Trap	Group
1	<input type="text"/>	Parse	n/a	<input type="checkbox"/>	1
2	<input type="text"/>	Parse	n/a	<input type="checkbox"/>	1
3	<input type="text"/>	Parse	n/a	<input type="checkbox"/>	1
4	<input type="text"/>	Parse	n/a	<input type="checkbox"/>	1
5	<input type="text"/>	Parse	n/a	<input type="checkbox"/>	1
6	<input type="text"/>	Parse	n/a	<input type="checkbox"/>	1
7	<input type="text"/>	Parse	n/a	<input type="checkbox"/>	1
8	<input type="text"/>	Parse	n/a	<input type="checkbox"/>	1

Below the table is a 'Submit Data' button.

Enter Description Information to Configure Your Relay

4. You will see a 'Successfully Submitted' dialog box. Click OK.
5. Return to 'Monitor Mode' by clicking the Monitor link.
6. Click on 'Exp.1 Controls'

7. Select the OPR option under the 'State' drop-down menu.

Exp.1 Controls			
ID	Description	Mode	State
1	RED	Normal	Rls
2		Normal	OPR
3		Normal	Rls
4		Normal	Mom
5		Normal	Rls
6		Normal	Rls
7		Normal	Rls
8		Normal	Rls

To Activate The Relay, Select OPR

8. You should hear a clicking noise coming from your Expansion Unit confirming the relay.

2.5.5 Setting Up an Analog

1. Click on the Edit link in the bottom left-hand corner of the Alarm Summary Window.
2. Once in the Edit screen, click 'Exp 1 Analogs'.
3. Enter the description for the analog, your threshold settings (Major Under/Over & Minor Under/Over), and select between primary or secondary pagers. Check to Trap box to send SNMP traps, and change the Unit value by clicking the link. Hit the Submit Data button when finished.

NetGuardian832-G5 v5.2E.0159

Exp.1 Analogs

ID	Description	Unit	Major Under	Minor Under	Minor Over	Major Over	Trap	Pagers	Pri	Sec
1	EXP 1	VDC	-5.0000	-10.0000	-30.0000	-40.0000	<input checked="" type="checkbox"/>	0	0	
2	EXP 2	VDC	-5.0000	-10.0000	-30.0000	-35.0000	<input checked="" type="checkbox"/>	0	0	
3	EXP 3	VDC	-5.0000	-10.0000	-30.0000	-35.0000	<input checked="" type="checkbox"/>	0	0	
4	EXP 4	VDC	-5.0000	-10.0000	-30.0000	-35.0000	<input checked="" type="checkbox"/>	0	0	
5	EXP 5	VDC	-5.0000	-10.0000	-30.0000	-35.0000	<input checked="" type="checkbox"/>	0	0	
6	EXP 6	VDC	-5.0000	-10.0000	-30.0000	-35.0000	<input checked="" type="checkbox"/>	0	0	
7	EXP 7	VDC	-5.0000	-10.0000	-30.0000	-35.0000	<input checked="" type="checkbox"/>	0	0	
8	EXP 8	VDC	-5.0000	-10.0000	-30.0000	-35.0000	<input checked="" type="checkbox"/>	0	0	

Submit Data

Enter Description Information to Configure Your Relay

4. You will see a 'Successfully Submitted' dialog box. Click OK.
5. Return to 'Monitor Mode' by clicking the Monitor link.
6. Click on 'Exp.1 Analogs'.

NetGuardian-G5

Exp.1 Analogs

Chn	Description	Reading	Units	MjU	MnU	MnO	MJO
1	EXP 1	-34.0478	VDC			x	
2	EXP 2	0.0593	VDC	x	x		
3	EXP 3	-27.1053	VDC				
4	EXP 4	-26.8785	VDC				
5	EXP 5	-35.0850	VDC			x	x
6	EXP 6	-21.5660	VDC				
7	EXP 7	0.0000	VDC	x	x		
8	EXP 8	0.0000	VDC	x	x		

The Monitor > Exp 1 Analogs screen

8. From here, you are able to view live analog reading from your NetGuardian expansion units.

3 Operation

3.1 Front Panel Functions



Fig. 3.1. The front panel displays alarm and communication status.

Label Descriptions

1. ACK button. The ACK button will acknowledge any new alarms (change of state (COS) alarms). It will also cause the shelf address (determined by the DIP switch accessible via top hatch) to be displayed by LEDs 1-3 when it is held down. And it will show the state of the relays.
2. Front panel LEDs. See Table 3.1 for LED indications.

LED	STATUS	DESCRIPTION
Config	Flashing Red	Invalid Shelf Address, check front panel DIP switch setting
	Flashing Green	Shelf Address set correctly
Link	Solid Green	
DX In	Flashing Green/Red	Grn = Transmit Red = Receive
DX Out	Flashing Green/Red	Grn = Transmit Red = Receive
Alarms 1-8	Green=Banks	A green flash indicates the point bank number (1-8). A point bank is comprised of 8 alarm points each.
	Red=Points	A red flash after the green point bank number flash indicates which of the 8 alarms in that point bank are in an alarmed state (see table below). Note: The Expansion alarm points are also displayed on the NetGuardian's LCD.

Table 3.1. NetGuardian Expansion LED indications (above), and alarm point designations per point bank

(below)

Note: The silkscreen designations "DX IN" and "DX OUT" do not indicate communication direction.

Point Bank	Alarm Points
1	1-8
2	9-16
3	17-24
4	24-32
5	32-40
6	41-48
7	49-56
8	57-64

3.2 Upgrading Firmware



Use the DSTniLoader to upgrade the firmware of your DX expansion. **NOTE:** This process should only be used when prompted by DPS Technical Support. To upload new firmware:

1. Connect your PC to the NetGuardian DX craft port, located on the front panel.
2. Install and launch DSTniLoader.
3. Click the Browse button and search for the firmware update you have saved on your PC.
4. Select the Com port you are connected to.
5. Click the Start button and reboot the unit when prompted. Reboot once more for firmware changes to take effect.

3.3 Display Mapping

Display numbers 1 through 11 in Table 3.2A correspond to the NetGuardian 864A, and Display numbers 12 through 17 (in bold) correspond to the NetGuardian Expansion unit.

Port	Address	Display	Description	Set	Clear
99	1	1	Discrete Alarms 1-32 For NG 864 Alarms 1-64	8001-8032 8001-8064	9001-9032 9001-9064
99	1	2	Ping Table	8065-8096	9065-9096
99	1	3	Analog Channel 1**	8129-8132	9129-9132
99	1	4	Analog Channel 2**	8193-8196	9193-9196
99	1	5	Analog Channel 3**	8257-8260	9257-9260
99	1	6	Analog Channel 4**	8321-8324	9321-9324
99	1	7	Analog Channel 5**	8385-8388	9385-9388
99	1	8	Analog Channel 6**	8449-8452	9449-9452
99	1	9	Analog Channel 7**	8513-8516	9513-9516
99	1	10	Analog Channel 8**	8577-8580	9577-9580
99	1	11	Relays/System Alarms (See table below)	8641-8674	9641-9674
99	1	12	NetGuardian Expansion 1 Alarms 1-64	6001-6064	7001-7064
99	1	12	NetGuardian 480 (as DX) Alarms 1-64	6001-6064	7001-7064
99	1	13	NetGuardian Expansion 1 Relays 1-8 or NetGuardian 480 (as DX) Relays 1-4	6065-6072	7065-7072
99	1	13	NetGuardian 480 (as DX) Alarms 65-80	6081-6096	7081-7096
99	1	14	NetGuardian Expansion 2 Alarms 1-64	6129-6192	7129-7192
99	1	15	NetGuardian Expansion 2 Relays 1-8	6193-6200	7193-7200
99	1	16	NetGuardian Expansion 3 Alarms 1-64	6257-6320	7257-7320
99	1	17	NetGuardian Expansion 3 Relays 1-8	6321-6328	7321-7328
99	1	18	Exp 1 Analogs, Channels 1 and 2 ***	6385-6392	7385-7392
99	1	19	Exp 1 Analogs, Channels 3 and 4 ***	6393-6400	7393-7400
99	1	20	Exp 1 Analogs, Channels 5 and 6 ***	6401-6908	7401-7408
99	1	21	Exp 1 Analogs, Channels 7 and 8 ***	6409-6416	7409-7416
99	1	22	Exp 2 Analogs, Channels 1 and 2 ***	6417-6424	7417-7424
99	1	23	Exp 2 Analogs, Channels 3 and 4 ***	6425-6432	7425-7432
99	1	24	Exp 2 Analogs, Channels 5 and 6 ***	6433-6440	7433-7440
99	1	25	Exp 2 Analogs, Channels 7 and 8 ***	6441-6448	7441-7448
99	1	26	Exp 3 Analogs, Channels 1 and 2 ***	6449-6456	7449-7456
99	1	27	Exp 3 Analogs, Channels 3 and 4 ***	6487-6464	7457-7464
99	1	28	Exp 3 Analogs, Channels 5 and 6 ***	6465-6472	7465-7472
99	1	29	Exp 3 Analogs, Channels 7 and 8 ***	6473-6480	7473-7480

Table 3.2.A. NetGuardian Expansion Display Mapping

* The TRAP number ranges shown correspond to the point range of each display. For example, the SNMP Trap "Set" number for alarm 1 (in Display 1) is 8001, "Set" for alarm 2 is 8002, "Set" for alarm 3 is 8003, etc.

** The TRAP number descriptions for the Analog channels (1-8) are in the following order: minor under, minor over, major under, and major over. For example, for Analog channel 1, the "Set" number for minor under is 8129, minor

over is 8130, major under is 8131, and major over is 8132.

*** Expansion analog channels use points 1-4 for the first channel in the display, and 33-36 for the second channel. Analogs thresholds are in the following order: Minor Under, Minor Over, Major Under, and Major Over.

Display 11 Point	Description
56	NGDdx 1 Fail (Expansion shelf 1 communication link failure)
57	NGDdx 2 Fail (Expansion shelf 2 communication link failure)
58	NGDdx 3 Fail (Expansion shelf 3 communication link failure)

Table 3.2.B. NetGuardian housekeeping display 11 alarm points for Expansion communication link failures

4 Technical Support

DPS Telecom products are backed by our courteous, friendly Technical Support representatives, who will give you the best in fast and accurate customer service. To help us help you better, please take the following steps before calling Technical Support:

1. Check the DPS Telecom website.

You will find answers to many common questions on the DPS Telecom website, at <http://www.dpstelecom.com/support/>. Look here first for a fast solution to your problem.

2. Prepare relevant information.

Having important information about your DPS Telecom product in hand when you call will greatly reduce the time it takes to answer your questions. If you do not have all of the information when you call, our Technical Support representatives can assist you in gathering it. Please write the information down for easy access. Please have your user manual and hardware serial number ready.

3. Have access to troubled equipment.

Please be at or near your equipment when you call DPS Telecom Technical Support. This will help us solve your problem more efficiently.

4. Call during Customer Support hours.

Customer support hours are Monday through Friday, from 7 A.M. to 6 P.M., Pacific time. The DPS Telecom Technical Support phone number is **(559) 454-1600**.

Emergency Assistance: Emergency assistance is available 24 hours a day, 7 days a week. For emergency assistance after hours, allow the phone to ring until it is answered with a paging message. You will be asked to enter your phone number. An on-call technical support representative will return your call as soon as possible.

5 End User License Agreement

All Software and firmware used in, for, or in connection with the Product, parts, subsystems, or derivatives thereof, in whatever form, including, without limitation, source code, object code and microcode, including any computer programs and any documentation relating to or describing such Software is furnished to the End User only under a non-exclusive perpetual license solely for End User's use with the Product.

The Software may not be copied or modified, in whole or in part, for any purpose whatsoever. The Software may not be reverse engineered, compiled, or disassembled. No title to or ownership of the Software or any of its parts is transferred to the End User. Title to all patents, copyrights, trade secrets, and any other applicable rights shall remain with the DPS Telecom.

DPS Telecom's warranty and limitation on its liability for the Software is as described in the warranty information provided to End User in the Product Manual.

End User shall indemnify DPS Telecom and hold it harmless for and against any and all claims, damages, losses, costs, expenses, obligations, liabilities, fees and costs and all amounts paid in settlement of any claim, action or suit which may be asserted against DPS Telecom which arise out of or are related to the non-fulfillment of any covenant or obligation of End User in connection with this Agreement.

This Agreement shall be construed and enforced in accordance with the laws of the State of California, without regard to choice of law principles and excluding the provisions of the UN Convention on Contracts for the International Sale of Goods. Any dispute arising out of the Agreement shall be commenced and maintained only in Fresno County, California. In the event suit is brought or an attorney is retained by any party to this Agreement to seek interpretation or construction of any term or provision of this Agreement, to enforce the terms of this Agreement, to collect any money due, or to obtain any money damages or equitable relief for breach, the prevailing party shall be entitled to recover, in addition to any other available remedy, reimbursement for reasonable attorneys' fees, court costs, costs of investigation, and other related expenses.

“Dependable, Powerful Solutions
that allow users to monitor larger,
more complicated networks with a
smaller, less trained staff”



"Your Partners in Network Alarm Management"

www.dpstelecom.com

4955 E Yale • Fresno, CA 93727

559-454-1600 • 800-622-3314 • 559-454-1688 fax